

RIGOL

Service Guide

DS1000E, DS1000D Series Digital Oscilloscopes

DS1102E, DS1052E, DS1102D, DS1052D

**Jun 2013
RIGOL Technologies, Inc.**

Copyright

© 2009 RIGOL Technologies, Inc. All Rights Reserved.

Trademark Information

RIGOL is registered trademark of **RIGOL** Technologies, Inc.

Notices

RIGOL products are protected by patent law in and outside of P.R.C..

RIGOL Technologies, Inc. reserves the right to modify or change parts of or all the specifications and pricing policies at company's sole decision.

Information in this publication replaces all previously corresponding material.

RIGOL shall not be liable for losses caused by either incidental or consequential in connection with the furnishing, use or performance of this manual as well as any information contained.

Any part of this document is forbidden to copy or photocopy or rearrange without prior written approval of **RIGOL**.

Safety Notices

Review the following safety precautions carefully before operating the instrument to avoid any personal injuries or damages to the instrument and any product connected to it. To prevent potential hazards, do use the instrument specified by this user's guide only.

The instrument should be serviced by qualified personnel only.

To avoid instrument damage or personnel injury caused by misoperation, the instrument should be serviced by qualified personnel only.

Use Proper Power Cord.

Use the power cord designed for the instrument and authorized in your country only.

Connect and Disconnect Accessories.

Do not connect or disconnect probes or test leads while they are connected to a voltage source.

Ground The Instrument.

The oscilloscope is grounded through the grounding conductor of the power cord. To avoid electric shock the instrument grounding conductor(s) must be grounded properly. Before making connections to the input or output terminals of the instrument.

Connect The Probe.

The probes' ground terminals are at the same voltage level of the instrument ground. Do not connect the ground terminals to a high voltage.

Observe All Terminal Ratings.

To avoid fire or shock hazard, observe all ratings and marks on the instrument. Follow the user's guide for further ratings information before making connections to the instrument.

Do Not Operate Without Covers.

Do not operate the instrument with covers or panels removed.

Use Proper Fuse.

Use the fuse of the type, voltage and current ratings as specified for the instrument.

Avoid Circuit or Wire Exposure.

Do not touch exposed connections and components when power is on.

Do Not Operate With Suspected Failures.

If suspected damage occurs with the instrument, have it inspected by qualified service personnel before further operations.

Keep Well Ventilation.

Inadequately ventilated will cause the temperature rises or damages to the device. Please keep well ventilation and inspect the intake and fan regularly.

Do not Operate in Wet/Damp Conditions.

In order to avoid short circuit to the interior of the device or electric shock, please do not operate in a humid environment.

Do not Operate in an Explosive atmosphere.

In order to avoid damages to the device or personal injury, please operate far away from an explosive atmosphere.

Keep Product Surfaces Clean and Dry.

In order to prevent the performance of the device from influencing by dust or water in air, please keep the surface of device clean and dry.

The disturbance test of all the models meet the limit values of A in the standard of EN 61326: 1997+A1+A2+A3, but can't meet the limit values of B.

Measurement Category

The DS1000E, DS1000D series Digital Oscilloscope is intended to be used for measurements in Measurement Category I.

Measurement Category Definitions

Measurement Category I is for measurements performed on circuits not directly connected to MAINS. Examples are measurements on circuits not derived from MAINS, and specially protected (internal) MAINS derived circuits. In the latter case, transient stresses are variable; for that reason, the transient withstand capability of the equipment is made known to the user.

WARNING

IEC Measurement Category I, The input terminals may be connected to circuit terminal in IEC Category I installations for voltages up to 300 VAC. To avoid the danger of electric shock, do not connect the inputs to circuit's voltages above 300 VAC. Transient overvoltage is also present on circuits that are isolated from mains. The DS1000E, DS1000D series Digital Oscilloscopes is designed to safely withstand occasional transient overvoltage up to 1000Vpk. Do not use this equipment to measure circuits where transient overvoltage could exceed this level.

Safety Terms and Symbols

Terms in this Guide. These terms may appear in this manual:



WARNING

Warning statements indicate the conditions or practices that could result in injury or loss of life.



CAUTION

Caution statements indicate the conditions or practices that could result in damage to this product or other property.

Terms on the Product. These terms may appear on the product:

DANGER indicates an injury or hazard that may immediately happen.

WARNING indicates a potential injury or hazard that may happen.

CAUTION indicates that a potential damage to the instrument or other property might occur.

Symbols on the Product. These symbols may appear on the product:



Hazardous
Voltage



Safety
Warning



Protective
Earth
Terminal



Chassis
Ground



Test
Ground

Document Overview

Chapter 1 Specifications

List the specifications and general specifications of DS1000E, DS1000D series.

Chapter 2 Prepare for Use

Introduce the preparatory work should be done before using the oscilloscope.

Chapter 3 Performance Test

Introduce how to execute the performance test to understand current performance status of the oscilloscope.

Chapter 4 Calibration

Introduce how to calibrate the oscilloscope.

Chapter 5 Disassembly and Assembly

Introduce how to disassemble and assemble the oscilloscope to understand its structure.

Chapter 6 Troubleshooting

List the troubles may appear during measuring and the corresponding solutions.

Chapter 7 Replaceable Parts

List the replaceable parts for user's repair or exchange.

Chapter 8 Service & Support

Provide the service and support information.

Contents

Safety Notices	II
Safety Terms and Symbols	IV
Document Overview	V
Contents	VI
Figures	VIII
Tables	IX
Chapter 1 Specifications	1-1
Specifications	1-2
General Specifications	1-5
Chapter 2 Prepare for Use	2-1
General Inspection	2-2
Power-On Inspection	2-3
Connect the Probe	2-4
Probe Compensation	2-5
Digital Probe (Only for DS1000D Series)	2-7
Display a Waveform Automatically	2-9
Chapter 3 Performance Test	3-1
Interfaces Test	3-2
USB Host Interface Test	3-2
USB Device Interface Test	3-4
RS-232 Interface Test	3-6
P/F Interface Test	3-8
Logic Analyzer Interface Test (Only for DS1000D Series)	3-9
Specifications Test	3-11
Impedance Test	3-12
DC Gain Accuracy Test	3-13
Bandwidth Test	3-15
Bandwidth Limit Test	3-17
Time Base Accuracy Test	3-20
Zero Point Offset Test	3-21
Chapter 4 Calibration	4-1
Chapter 5 Disassembly and Assembly	5-1
Notices	5-2
Structure Chart	5-3
Disassemble and Assemble the Cover	5-4
Disassemble and Assemble the Upper and Rear Covers	5-5
Disassemble and Assemble the Power Board and the Fan	5-6
Disassemble and Assemble the Panel	5-8
Disassemble and Assemble LCD and the Keyboard	5-9

Disassemble and Assemble the Mainboard 5-10

Chapter 6 Troubleshooting 6-1

Chapter 7 Replaceable Parts 7-1

Chapter 8 Service & Support 8-1

 Warranty 8-2

 Care and Cleaning 8-3

 Contact Us 8-4

Figures

Figure 2-1 Connect the power cord	2-3
Figure 2-2 Power-on inspection	2-3
Figure 2-3 Connect probe to oscilloscope	2-4
Figure 2-4 Connect probe to circuit	2-4
Figure 2-5 Set the probe attenuation quotient and switch	2-5
Figure 2-6 Connect the probe compensator	2-5
Figure 2-7 Waveform compensation	2-6
Figure 2-8 Connect the digital probes to oscilloscope	2-7
Figure 2-9 Test clip of digital probe	2-7
Figure 2-10 Attach the clip to testing point	2-8
Figure 2-11 Connect to the ground	2-8
Figure 3-1 Connect the U disk	3-2
Figure 3-2 Successful prompt of USB interface connection	3-2
Figure 3-3 USB Device interface connection	3-4
Figure 3-4 Select USB interface	3-4
Figure 3-5 Fail to connection	3-5
Figure 3-6 RS-232 interface connection	3-6
Figure 3-7 Select RS-232 interface	3-6
Figure 3-8 RS-232 interface setting	3-7
Figure 3-9 Fail prompt of RS-232 interface connection	3-7
Figure 3-10 P/F interface connection	3-8
Figure 3-11 DS1000D LA interface connection	3-9
Figure 3-12 Setting interface	3-10
Figure 3-13 Edge trigger of digital channel	3-10
Figure 4-1 Self-Calibration interface	4-1
Figure 4-2 Finish Self-Calibration	4-1
Figure 5-1 Structure chart	5-3
Figure 5-2 Disassemble and assemble the cover	5-4
Figure 5-3 Disassemble and assemble the upper and rear covers	5-5
Figure 5-4 Disassemble and assemble the power board and the fan	5-6
Figure 5-5 Disassemble and assemble the panel	5-8
Figure 5-6 Disassemble and assemble LCD and the keyboard	5-9
Figure 5-7 Disassemble and assemble the mainboard	5-10
Figure 7-1 DS1000E, DS1000D Exploded View	7-1

Tables

Table 2-1 The auto items.....	2-9
Table 3-1 Pass/Fail setting items.....	3-8
Table 7-1 Replaceable parts list.....	7-2

Chapter 1 Specifications

All specifications apply to DS1000E, DS1000D series Oscilloscopes unless noted otherwise. To meet these specifications, two conditions must first be met:

- The instrument must have been operating continuously for thirty minutes within the specified operating temperature.
- Do perform the "Self Cal" operation, accessible through the Utility menu, if the operating temperature changes by more than 5°C.

NOTE: All specifications are guaranteed unless noted "typical".

Specifications

Acquisition				
Sampling Modes	Real-Time		Equivalent	
Sampling Rate	1GSa/s ^[1] , 500MSa/s		DS1102X	DS1052X
			25GSa/s	10GSa/s
Averages	N time acquisitions, all channels simultaneously, N is selectable from 2, 4, 8, 16, 32, 64, 128 and 256.			
Inputs				
Input Coupling	DC, AC, GND			
Input Impedance	1MΩ±2% 18pF±3pF			
Probe Attenuation Factors	1X, 5X, 10X, 50X, 100X, 500X, 1000X			
Maximum Input Voltage	400V (DC+AC Peak, 1MΩ input impedance) 40V (DC+AC Peak) ^[1]			
Time delay between channel (typical)	500ps			
Horizontal				
Sample Rate Range	Real-Time: 13.65Sa/s-1GSa/s Equivalent: 13.65Sa/s-25GSa/s			
Waveform interpolation	Sin(x)/x			
Record Length	Channel Mode	Sample rate	Record Length (normal)	Record Length (long record)
	Single channel	1GSa/s	16kpts	N.A.
	Single channel	500MSa/s Or lower	16kpts	1Mpts
	Double channel	500MSa/s Or lower	8kpts	N.A.
	Double channel	250MSa/s Or lower	8kpts	512kpts
Scan speed Range (Sec/div)	2ns/div~50s/div, DS1102X 5ns/div~50s/div, DS1052X 1-2-5 Sequence			
Sample Rate and Delay Time Accuracy	±50ppm (over any 1ms time interval)			
Delta Time Measurement Accuracy (Full Bandwidth)	Single-shot: ±(1 sample interval + 50ppm × reading + 0.6 ns) >16 averages: ±(1sample interval + 50ppm × reading + 0.4 ns)			
Vertical				

A/D converter	8-bit resolution, each channel samples simultaneously ^[2]
Volts/div Range	2mV/div~10V/div at input BNC
Maximum Input	Analog channel maximum input voltage CAT I 300Vrms, 1000Vpk; instantaneous voltage 1000Vpk CAT II 100Vrms, 1000Vpk RP2200 10:1: CAT II 300Vrms RP3200 10:1: CAT II 300Vrms RP3300 10:1: CAT II 300Vrms
Offset Range	$\pm 40V(250mV/div \sim 10V/div)$, $\pm 2V(2mV/div \sim 245mV/div)$
Analog Bandwidth	100MHz (DS1102D, DS1102E) 50MHz (DS1052D, DS1052E)
Single-shot Bandwidth	100MHz (DS1102D, DS1102E) 50MHz (DS1052D, DS1052E)
Selectable Analog Bandwidth Limit (typical)	20MHz
Lower Frequency Limit (AC -3dB)	$\leq 5Hz$ (at input BNC)
Rise Time at BNC, typical	<3.5ns, <7ns, On (100MHz, 50MHz) respectively
Dynamic range	$\pm 5div$
DC Gain Accuracy	2mV/div-5mV/div: $\pm 4%$ (Normal or Average acquisition mode) 10mV/div-10V/div: $\pm 3%$ (Normal or Average acquisition mode)
DC Measurement Accuracy, Average Acquisition Mode	Average of ≥ 16 Waveforms with vertical position at zero: $\pm (DC \text{ Gain Accuracy} \times \text{reading} + 0.1div + 1mV)$ Average of ≥ 16 Waveforms with vertical position not at zero: $\pm [DC \text{ Gain Accuracy} \times (\text{reading} + \text{vertical position}) + (1\% \text{ of vertical position}) + 0.2div]$ Add 2mV for settings from 2mV/div to 245 mV/div Add 50mV for settings from >250mV/div to 10V/div
Delta Volts Measurement Accuracy (Average Acquisition Mode)	Delta Volts between any two averages of 16 waveforms acquired under same setup and ambient conditions: $\pm (DC \text{ Gain Accuracy} \times \text{reading} + 0.05 div)$

Trigger

Trigger Sensitivity	0.1div~1.0div (adjustable)	
Trigger Level Range	Internal	± 6 divisions from center of screen
	EXT	$\pm 1.2V$
Trigger Level Accuracy (typical) applicable for the signal of rising and falling time $\geq 20ns$	Internal	$\pm (0.3div \times V/div)(\pm 4$ divisions from center of screen)
	EXT	$\pm (6\% \text{ of setting} + 200 mV)$

Trigger Offset	Normal mode: pre-trigger (storage depth/ 2*sampling rate), delayed trigger 1s	
	Slow Scan mode: pre-trigger 6div, delayed trigger 6div	
Trigger Holdoff range	500ns~1.5s	
Set Level to 50% (Typical)	Input signal frequency $\geq 50\text{Hz}$	
Edge Trigger		
Edge trigger slope	Rising, Falling, Rising + Falling	
Pulse Trigger		
Trigger condition	$(>, <, =)$ Positive pulse, $(>, <, =)$ negative pulse	
Pulse Width range	20ns ~10s	
Video Trigger		
Video standard & line frequency	Support standard NTSC, PAL and SECAM broadcast systems. Line number range: 1~525 (NTSC) and 1~625 (PAL/SECAM)	
Slope Trigger		
Trigger condition	$(>, <, =)$ Positive slope, $(>, <, =)$ negative slope	
Time setting	20ns~10s	
Alternate Trigger		
Trigger on CH1	Edge, Pulse, Video, Slope	
Trigger on CH2	Edge, Pulse, Video, Slope	
Pattern Trigger ^[2]		
Trigger mode	D0~D15 select H, L, X, \mathbb{F} , \mathbb{T}	
Duration Trigger ^[2]		
Trigger Type	D0~D15 select H, L, X	
Qualifier	$>, <, =$	
Time setup	20ns~10s	
Measurements		
Cursor	Manual	Voltage difference between cursors (ΔV) Time difference between cursors (ΔT) Reciprocal of ΔT in Hertz ($1/\Delta T$)
	Track	Voltage value for Y-axis waveform Time value for X-axis waveform
	Auto	Cursors are visible for Automatic Measurement
Auto Measure	Vpp, Vamp, Vmax, Vmin, Vtop, Vbase, Vavg, Vrms, Overshoot, Preshoot, Freq, Period, Rise Time, Fall Time, +Width, -Width, +Duty, -Duty, Delay1 \rightarrow 2 \mathbb{F} , Delay1 \rightarrow 2 \mathbb{T}	

Remarks:

[1] When sampling is 1GSa/s, only single channel can be used.

[2] For DS1000D series.

General Specifications

Display		
Display Type	5.7 in. (145 mm) diagonal TFT Liquid Crystal Display	
Display Resolution	320 horizontal ×RGB×234 vertical pixels	
Display Color	64k color	
Display Contrast (typical)	150:1	
Backlight Brightness(typical)	300 nit	
Probe Compensator Output		
Output Voltage(typical)	Approximately 3Vpp (peak to peak value)	
Frequency(typical)	1kHz	
Power		
Supply Voltage	100 ~ 240 VAC _{RMS} , 45~440Hz, CAT II	
Power Consumption	Less than 50W	
Fuse	2A, T rating, 250 V	
Environmental		
Ambient Temperature	Operating 10°C ~ 40°C	
	Non-operating -20°C ~ +60°C	
Cooling Method	Fan force air flow	
Humidity	+35°C or below: ≤90% relative humidity	
	+35°C ~ +40°C: ≤60% relative humidity	
Altitude	Operating 3,000 m or below	
	Non-operating 15,000 m or below	
Mechanical		
Size	Width	303mm
	Height	154mm
	Depth	133 mm
Heavy	Without package	2.3 kg
	Packaged	3.5 kg
IP Protection		
IP2X		
Calibration Interval		
The recommended calibration interval is one year		

Chapter 2 Prepare for Use

This chapter contains the following topics:

- General Inspection
- Power-On Inspection
- Connect the Probe
- Probe Compensation
- Digital Probe (Only for DS1000D Series)
- Display a Waveform Automatically

General Inspection

When you get a new DS1000E, DS1000D series oscilloscope, please inspect the instrument according to the following steps:

1. Inspect the shipping container for damage.

Keep a damaged shipping container and cushioning material until the contents of the shipment have been checked for completeness and the instrument has been checked mechanically and electrically.

2. Inspect the instrument.

In case there is any mechanical damage or defect, or the instrument does not operate properly or fails performance tests, please notify the **RIGOL** Sales Representative.

If the shipping container is damaged, or the cushioning materials show signs of stress, please notify the carrier as well as the **RIGOL** sales office. Keep the shipping materials for the carrier's inspection. **RIGOL** offices will arrange for repair or replacement at **RIGOL**'s option without waiting for claim settlement.

3. Check the accessories.

Accessories supplied with the instrument are listed below. If the contents are incomplete or damaged, please notify the **RIGOL** Sales Representative.

Standard Accessories:

- Probe×2 (1.5m), (1:1 or 10:1 adjustable) Passive Probes
The passive probes have a 6MHz bandwidth with a rating of 150V CAT II when the switch is in the 1X position, and a Full oscilloscope bandwidth with a rating of 300 V CAT II when the switch is in the 10X position.
- A Power Cord that fits the standard of destination country
- An USB Cable
- A Logic Cable (only for DS1000D series)
- An active logic head (only for DS1000D series)
- 20 Logic Testing Nips (only for DS1000D series)
- 20 Logic Testing Leads (only for DS1000D series)
- A CD-ROM (including "User's Guide" and Application Software)
- A Quick Guide

Power-On Inspection

Generally, normal operating voltage and frequency for DS1000E, DS1000D series digital oscilloscope are 100-240V_{RMS} and 45-440Hz respectively. Please connect one terminal of the power cord to the socket in left side of the oscilloscope and the other to the AC power source.

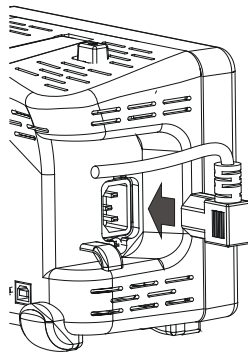

Figure 2-1 Connect the power cord

Press the power button on top of the oscilloscope, some keys on the front panel will light for about 2 seconds until the normal display appears. And then you can operate the oscilloscope.



WARNING

To avoid the electric shock, make sure the oscilloscope is under good grounding before connecting AC power.

After power-on, the oscilloscope performs all the self-testing automatically. Then, press **Storage** and select **Storage** to recall the **Factory** settings after passing test (the screen will appear).

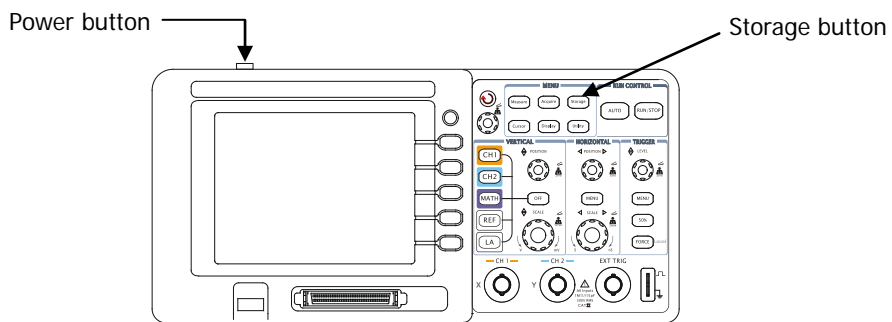

Figure 2-2 Power-on inspection

Connect the Probe

DS1000E series is a type of digital oscilloscope with dual channel inputs and one external trigger input. While, DS1000D series is a type with dual channel input, one external trigger input and sixteen channel digital inputs.

Please take the following steps to connect the probe:

1. Attach BNC connector of the probe to the channel input or external trigger interfaces, insert it vertically until it latches into places. Then circumvolve the BNC connector clockwise to get a firm connection.

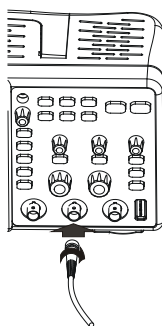

Figure 2-3 Connect probe to oscilloscope

2. Connect the other end of probe to circuit under test.

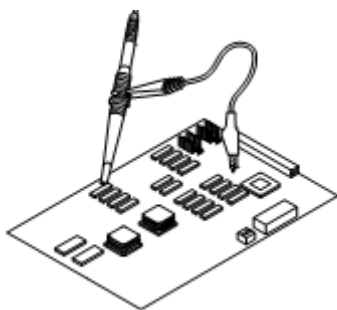

Figure 2-4 Connect probe to circuit

3. Disconnect the circuit after testing, and then circumvolve the BNC connector of probe anticlockwise, and pull it out of the interface vertically.



WARNING

When use 10:1 attenuation probe, don't input a signal with higher than maximum input voltage.

Probe Compensation

You are suggested to compensate probe before first using so as to match its characteristics with oscilloscope. Measurement error may be generated without compensation or because of deviation compensation. To compensate the probe, follow the steps below.

1. Set both the attenuation switch of the probe and the probe scale in the menu to 10X.

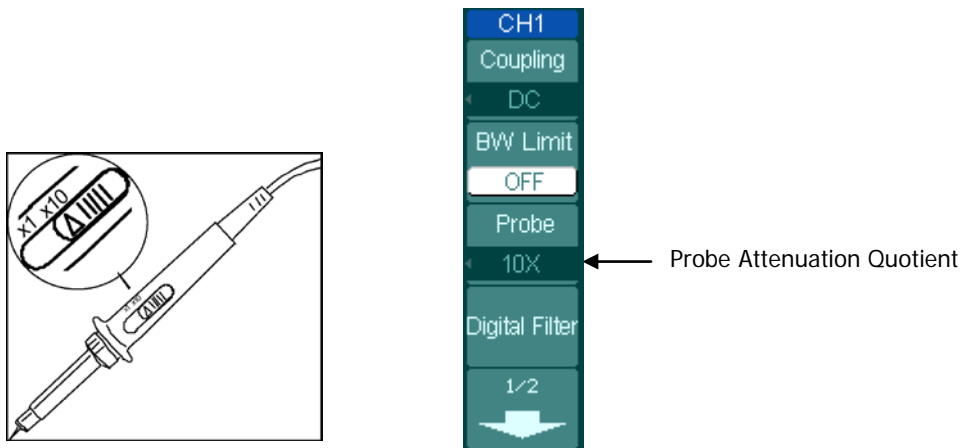

Figure 2-5 Set the probe attenuation quotient and switch

2. Connect the probe to CH1. And attach both the probe tip and ground lead to the connector of probe compensator.

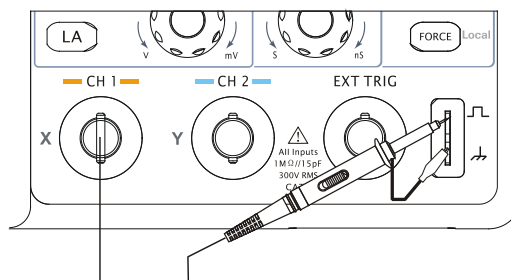

Figure 2-6 Connect the probe compensator

3. Open CH1 and press **AUTO** button after a few seconds, a square wave will be displayed (1 kHz, approximately 3 V peak- to- peak). Check if the compensation is

correct in accordance with the shape of waveform.

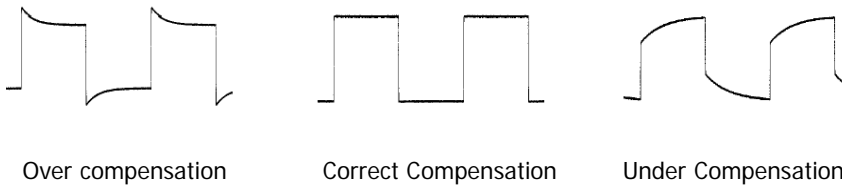

Figure 2-7 Waveform compensation

4. If necessary, use a non-metallic screwdriver to adjust the variable capacitor of the probe until a "Correct Compensation" wave displayed on the screen.
5. Continue in the same way to check CH2.



WARNING

To avoid electric shock while using the probe, be sure the perfection of the insulated cable, and do not touch the metallic portions of the probe head while it is connected with a high-voltage power supply.

Digital Probe (Only for DS1000D Series)

DS1000D series provide sixteen digital channels. Take the steps below to connect instrument and test points by digital probes:

1. Switch off power supply of the device under test if necessary to avoid short circuit. Since no voltage is applied to the leads at this step, you may keep the oscilloscope on.
2. Connect one terminal of the flat cable FC1868 to the Logic Analyzer Input; connect the other end to Logic Head LH1116. An identifier is located on each end of the flat cable; it can only be connected in one way. It is unnecessary to switch off power supply of your oscilloscope when connecting the cable.

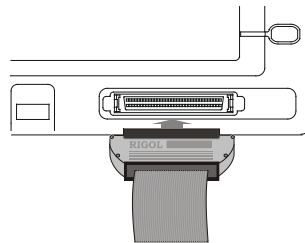

Figure 2-8 Connect the digital probes to oscilloscope



CAUTION

Use only FC1868, LH1116, TC1100 and LC1150 made by **RIGOL** for specified DS1000D series.

3. Connect a test clip to one lead wire; make sure it's connection good.

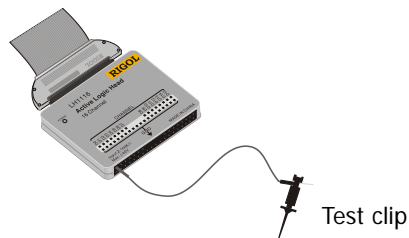

Figure 2-9 Test clip of digital probe

4. Connect the test clip to the ground.

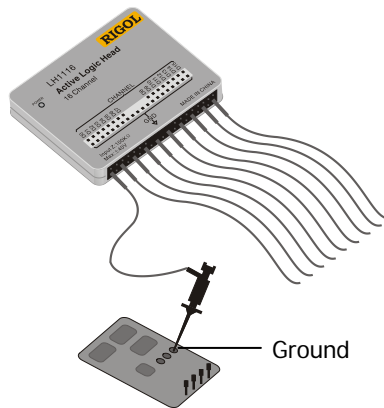

Figure 2-10 Connect to the ground

5. Test your device with the clip.

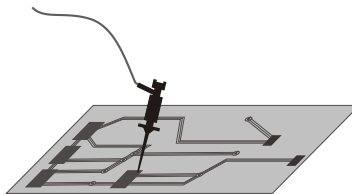

Figure 2-11 Attach the clip to testing point

Display a Waveform Automatically

DS1000E, DS1000D series digital oscilloscopes have an automatic feature to display the input signal best-fit. The oscilloscope enables to automatically set up VERTICAL, HORIZONTAL and TRIGGER parameters for the input signal under display. The input signal should be 50Hz or higher of frequency and the duty cycle of which should greater than 1%.

1. Operation steps

- Connect a signal to input channel.
- Press **AUTO** and adjust parameters manually to get the best display if necessary.

2. Auto settings

Table 2-1 The auto items

Functions	Settings
Display format	Y-T
Acquire mode	Normal
Vertical coupling	Adjust to AC or DC according to the signal.
Vertical "V/div"	Adjust to right position
Volts/Div	Coarse
Bandwidth limit	Full
Signal Invert	OFF
Horizontal position	Center
Horizontal "S/div"	Adjust to right position
Trigger type	Edge
Trigger source	Find the channel with input signal automatically.
Trigger coupling	DC
Trigger voltage	Midpoint setting
Trigger mode	Auto
 POSITION knob	Trigger offset

Chapter 3 Performance Test

This chapter contains the following topics:

- Interfaces Test
 - USB Host Interface Test
 - USB Device Interface Test
 - RS-232 Interface Test
 - P/F Interface Test
 - Logic Analyzer Interface Test (Only for DS1000D Series)
- Specifications Test
 - Impedance Test
 - DC Gain Accuracy Test
 - Bandwidth Test
 - Bandwidth Limit Test
 - Time Base Accuracy Test
 - Zero Point Offset Test

Interfaces Test

USB Host Interface Test

Purpose:

Test if the **USB Host** interface works normally through U disc.

Tools:

- A set of DS1000E, DS1000D series digital oscilloscope
- An U disk

Steps:

1. Insert the U disk into the USB Host interface on the front panel of the oscilloscope.

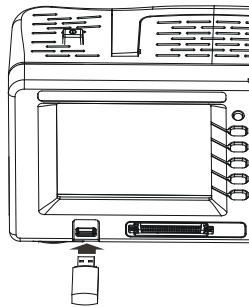

Figure 3-1 Connect the U disk

2. Wait until a prompt "USB device install success" appeared on the screen, which indicates the USB Host interface works normally, otherwise, you need to check or repair this interface.

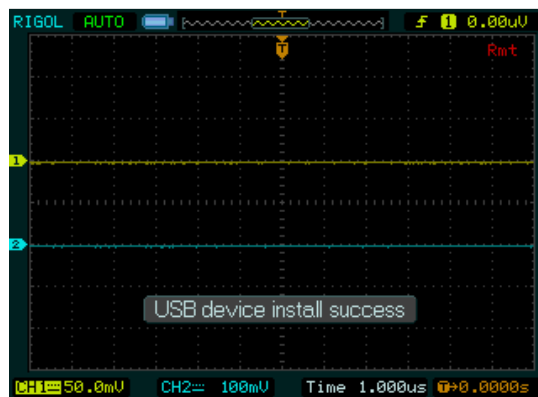

Figure 3-2 Successful prompt of USB interface connection

3. If an update program about the oscilloscope available in the U disc is detected, a prompt will appeared to ask you whether to update or not; if select OK, the corresponding update process will be shown on the screen.
4. Press **Storage** → **External** to copy or delete the information in U disc.
5. Remove the U disc and a corresponding prompt "USB device removed" will appear.

USB Device Interface Test

Purpose:

Test if the **USB Device** interface works normally through Ultrascope for DS1000E, DS1000D series.

Tools:

- A set of DS1000E, DS1000D series digital oscilloscope
- A PC with USB interface
- A standard USB cable (Type AB)
- Ultrascope for DS1000E, DS1000D series

Steps:

1. Install the Ultrascope for DS1000E, DS1000D series software on the PC.
2. Connect the oscilloscope with PC using an USB cable, and install the driver program step by step following the prompt.

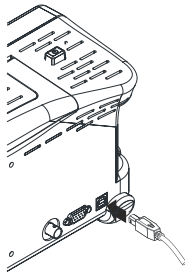

Figure 3-3 USB Device interface connection

3. Run Ultrascope for DS1000E, DS1000D series, then click **Tools**→**Options** and select **USB** as the current **IO**.

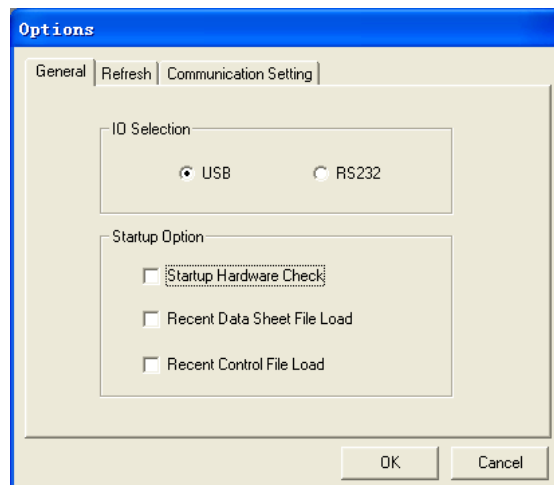

Figure 3-4 Select USB interface

4. Click **Tools**→**Connect to Oscilloscope**; If successful, the corresponding indicator at the upper right corner of the software will be changed from red to blue; if failed, a prompting message will be appeared as below.



Figure 3-5 Fail to connection

Hint

For the newest version of this software please go to www.rigolna.com download.

RS-232 Interface Test

Purpose:

Test if **RS-232** interface works normally through Ultrascope for DS1000E, DS1000D series.

Tools:

- A set of DS1000E, DS1000D series digital oscilloscope
- A PC with RS-232 interface
- A standard RS-232 cable
- Ultrascope for DS1000E, DS1000D series

Steps:

1. Install the Ultrascope for DS1000E, DS1000D series software on the PC.
2. Connect the oscilloscope with PC using an RS-232 cable.

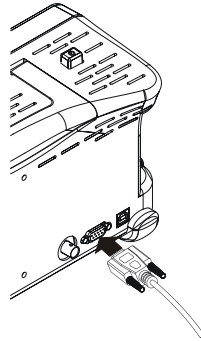

Figure 3-6 RS-232 interface connection

3. Run Ultrascope for DS1000E, DS1000D Series, then click **Tools**→**Options** and select **RS-232** as the current **IO**.

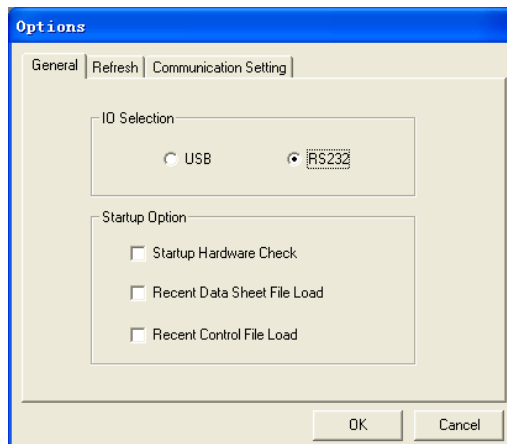

Figure 3-7 Select RS-232 interface

4. Click **Communication Setting** and setup the communication interface under using and the baud rate.

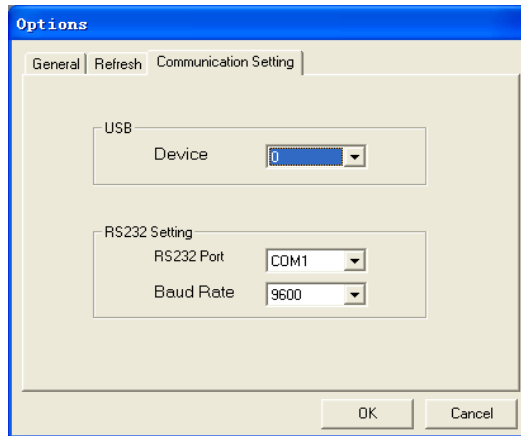

Figure 3-8 RS-232 interface setting

5. Press **Utility** → **I/O Setting** and set the baud rate as the same value in Ultrascope.
6. Click **Tools** → **Connect to Oscilloscope**; If successful, the corresponding reminder light at the upper right corner of the software will be changed from red to blue; otherwise, a prompting message will be appeared as below.

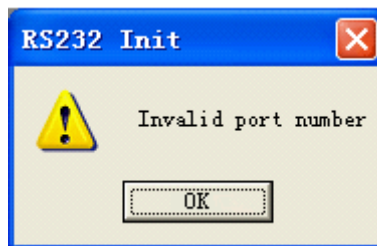

Figure 3-9 Fail prompt of RS-232 interface connection

P/F Interface Test

Purpose:

Test if **P/F** interface work normally.

Tools:

- A set of DS1000E, DS1000D series digital oscilloscope
- A BNC cable

Steps:

1. Power on the DS1000E and DS1000D respectively.
2. Connect the P/F interface at the rear panel of the DS1000E and the CH1 channel of the DS1000D using the BNC cable.

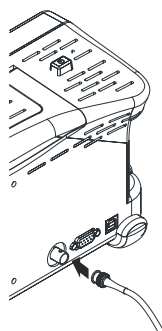

Figure 3-10 P/F interface connection

3. Turn on the oscilloscope, press **Storage** → **Storage** → **Factory** to recall the factory settings.
4. Press **Utility** → **Pass/fail** to enter the setting interface of Pass/Fail, see the table below.

Table 3-1 Pass/Fail setting items

Items	Setting
Enable Test	ON
Source	CH1
Msg display	ON
Output	Fail
Stop on Output	OFF

5. After setting, press **Operate** to start Pass/Fail test.
6. When the test failed, observe the CH1 channel of the DS1000D. If a pulse waveform is displayed, it indicates that the interface works normally. If there is no response, errors might be happened to the interface. At this point, you need to inspect or mend the interface.
7. Using the same method to test if **P/F** interface of the DS1000D work normally.

Logic Analyzer Interface Test (Only for DS1000D Series)

Purpose:

Test if the Logic Analyzer (hereinafter referred to as LA) interface works normally through the logic signal output module (DG-POD-A) of DG3000.

Tools:

- A set of DS1000D series digital oscilloscope
- A set of DG3000 Function/ Arbitrary waveform Generator
- An active logic head
- Two logic cables
- 17 logic testing leads
- A DG-POD-A module

Steps:

1. Connect LA interface on DS1000D with the active logic head by logic cable.
2. Connect "DIGITAL OUTPUT" interface on the rear panel of DG3000 with DG-POD-A module by logic cable.
3. Connect the active logic head with DG-POD-A module by logic testing leads, so as to realize DS1000D and DG3000 connection.

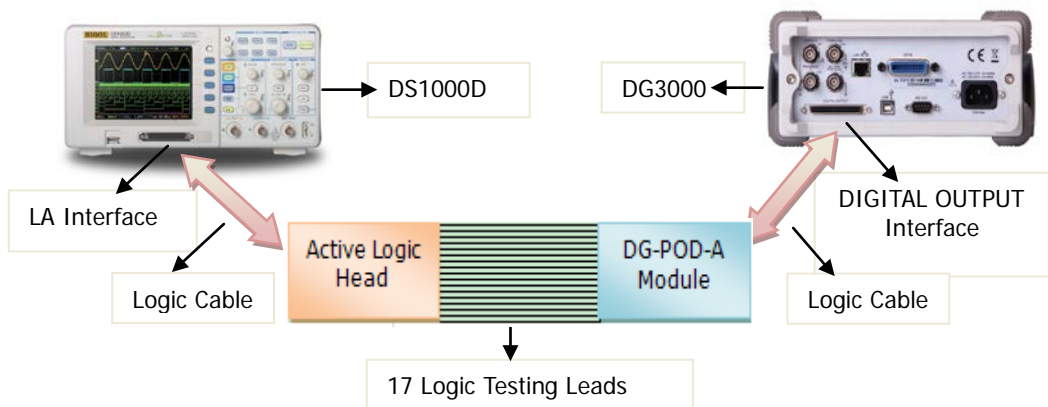

Figure 3-11 DS1000D LA interface connection

4. Power on DS1000D and DG3000 respectively.
5. Turn on DG3000 and press **Utility** → **Output Setup** → **Digit-Modu** → **Power on** to enable the digital module power on.
6. Press **Arb** → **Edit Digital W**, select **Protocol** → **PO**, **Code Pat** → **32PRBS** and adjust **Output Length** as 16 Byte as follows, then press **Arb** button to output digital signal.

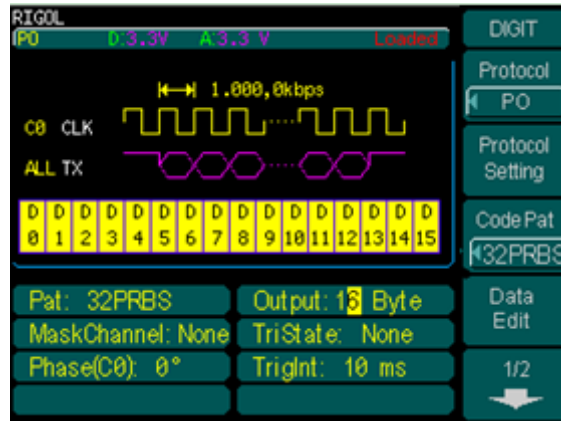

Figure 3-12 Setting interface

7. Press **LA** button on the oscilloscope, select **D7-D0** and **D15-D8** to open all the logic channels.
8. Select **EDGE** mode under the trigger menu and select any one source among Do to D15, if obtain the stable interface as follows, the LA module will be proved works normally.

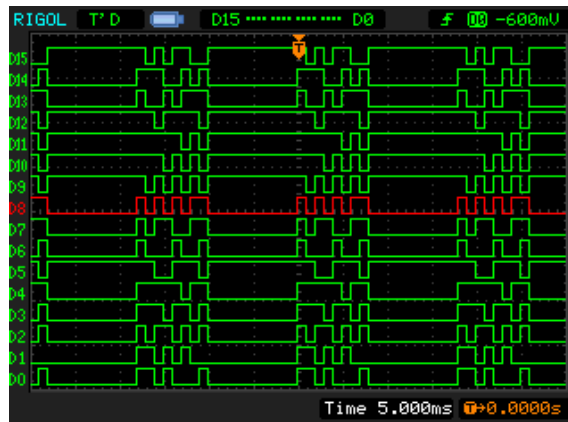

Figure 3-13 Edge trigger of digital channel

Specifications Test

This section introduces the performance verification test method of DS1000E/DS1000D series digital oscilloscope by taking DS1102E as an example. You can perform the following test in any order. In this manual, the test device used is Fluke 9500B. You can also use other devices that fulfill the specification requirements for the test.

Recommended Devices List:

Device	Specification	Recommended Model
Oscilloscope Calibrator	Output range of DC voltage: 1 M Ω : 1 mV to 200 V 50 M Ω : 1 mV to 200 V The rise time of fast edge signal: ≤ 150 ps	Fluke 9500B
Digital Multimeter	The resistance measurement accuracy is higher than $\pm 0.1\%$ of reading	RIGOL DM3058/3068
Test Cable	BNC (male) to Dual-banana Plug Cable	--
Signal Generator	Frequency Accuracy: ± 1 ppm	RIGOL DG4162
Test Cable	BNC (m)-BNC (m) cable	--

Note:

- 1) Make sure that the oscilloscope passes the self-calibration before performing the performance calibration test.
- 2) Make sure that the oscilloscope has been warmed up for 30 minutes before executing any of the following tests.
- 3) Please reset the instrument to the factory setting before or after executing any of the following tests.

Impedance Test



Specifications:

Input Impedance	1 M Ω \pm 2% (0.98 M Ω to 1.02 M Ω)
-----------------	---

Test Devices: Fluke 9500B or Digital Multimeter and BNC (male) to Dual-banana Plug Cable. In this manual, the test device is Fluke 9500B.

Test Procedures:

1. Impedance test of CH1 and CH2

- 1) Connect the active head of Fluke 9500B to CH1 of the oscilloscope.
- 2) Configure the oscilloscope:
 - a) Press **CH1** in the vertical control area (VERTICAL) at the front panel to enable CH1.
 - b) Rotate **VERTICAL**  **SCALE** to set the vertical scale of CH1 to 100 mV/div.
- 3) Enable the Fluke 9500B and select the resistance measurement function, read and record the resistance measurement value.
- 4) Rotate **VERTICAL**  **SCALE** to adjust the vertical scale of CH1 to 500 mV/div; then, read and record the resistance measurement value.
- 5) Turn CH1 off. Repeat the above test steps to test CH2 and record the test results.

2. Impedance test of [EXT TRIG] channel

- 1) Disconnect the connections of the two input channels.
- 2) Connect the active head of Fluke 9500B to the external trigger channel **[EXT TRIG]**.
- 3) Enable the Fluke 9500B and select the resistance measurement function, read and record the resistance measurement value.

Test Record Form:

Channel	Vertical Scale	Test Result	Limit	Pass/Fail
CH1	100 mV/div		$\geq 0.98 \text{ M}\Omega$ and $\leq 1.02 \text{ M}\Omega$	
	500 mV/div			
CH2	100 mV/div			
	500 mV/div			
EXT TRIG	--			





DC Gain Accuracy Test

Specifications:

DC Gain Accuracy	$\leq 4\% \times \text{Full Scale}$ (2 mV/div to 5 mV/div) $\leq 3\% \times \text{Full Scale}$ (10 mV/div to 10 V/div)
Explanation: Full Scale = 8 div \times vertical scale. Relative error of each scale: $ (V_{\text{avg1}} - V_{\text{avg2}}) - (V_{\text{out1}} - V_{\text{out2}}) / \text{Full Scale} \times 100\% \leq X\%$ (the value of X is 3 when the vertical scale is 10 mV/div to 10 V/div and the value of X is 4 when the vertical scale is 2 mV/div to 5 mV/div); otherwise, the test fails. For example, when the vertical scale is 1 V/div, input DC signals with +3 V _{DC} and -3 V _{DC} voltages respectively, the values of V _{avg1} and V _{avg2} are +3.06 V and -3.04 V respectively, the relative error is $ (+3.06 \text{ V} - (-3.04 \text{ V}) - (+3 \text{ V} - (-3 \text{ V})) / (1 \text{ V/div} \times 8 \text{ div}) \times 100\% = 1.25\%$ and the test passes.	

Test Device: Fluke 9500B

Test Procedures:

- 1) Connect the active head of Fluke 9500B to CH1 of the oscilloscope.
- 2) Enable Fluke 9500B and set the output impedance to 1 M Ω .
- 3) Output a DC signal with +6 mV_{DC} voltage (V_{out1}) from Fluke 9500B.
- 4) Configure the oscilloscope:
 - a) Press **CH1** in the vertical control area (VERTICAL) at the front panel to enable CH1.
 - b) Rotate **VERTICAL**  **SCALE** to set the vertical scale to 2 mV/div.
 - c) Rotate **HORIZONTAL**  **SCALE** to set the horizontal time base to 10 μ s.
 - d) Rotate **VERTICAL**  **POSITION** to set the vertical position to 0.
 - e) Press **Acquire** \rightarrow **Acquisition** and use  to select "Average". Then, press **Averages** and use  to set the number of averages to 32.
- 5) Enable the average measurement function of the oscilloscope. Read and record V_{avg1}.
- 6) Adjust Fluke 9500B to output a DC signal with -6 mV_{DC} voltage (V_{out2}).
- 7) Read and record the average value V_{avg2} at the moment.
- 8) Calculate the relative error of the vertical scale:
 $|(V_{\text{avg1}} - V_{\text{avg2}}) - (V_{\text{out1}} - V_{\text{out2}})| / \text{Full Scale} \times 100\%$.
- 9) Keep other settings of the oscilloscope unchanged:
 - a) Set the vertical scale to 5 mV/div, 10 mV/div, 20 mV/div, 50 mV/div, 100 mV/div, 200 mV/div, 500 mV/div, 1 V/div, 2 V/div, 5 V/div and 10 V/div respectively.
 - b) Adjust the output voltage of Fluke 9500B to ± 3 div respectively.
 - c) Repeats steps 2), 3), 4), 5), 6) and 7) and record the results.
 - d) Calculate the relative error of each scale.
- 10) Turn CH1 off. Repeat the above test steps to test CH2 and record the test results.

Test Record Form:

Channel	Vertical Scale	Test Result			Limit	Pass/Fail
		Vavg1	Vavg2	Calculation Result ^[1]		
CH1	2 mV/div				≤4%	
	5 mV/div					
	10 mV/div				≤3%	
	20 mV/div					
	50 mV/div					
	100 mV/div					
	200 mV/div					
	500 mV/div					
	1 V/div					
	2 V/div					
	5 V/div					
	10 V/div					
CH2	2 mV/div				≤4%	
	5 mV/div					
	10 mV/div				≤3%	
	20 mV/div					
	50 mV/div					
	100 mV/div					
	200 mV/div					
	500 mV/div					
	1 V/div					
	2 V/div					
	5 V/div					
	10 V/div					

Note^[1]: the calculation formula is $|(V_{avg1}-V_{avg2})-(V_{out1}-V_{out2})|/Full\ Scale \times 100\%$; wherein, V_{out1} and V_{out2} are 3 and -3 times of the current vertical scale respectively.







Bandwidth Test

Specification:

Amplitude Loss	-3 dB to 1 dB
Explanation: Amplitude loss (dB) = $20 \times \lg(V_{\text{rms2}}/V_{\text{rms1}})$.	

Test device: Fluke 9500B

Test Procedures:

- 1) Connect the active head of Fluke 9500B to CH1 of the oscilloscope.
- 2) Enable the Fluke 9500B and set the output impedance to 1 MΩ.
- 3) Output a sine signal with 1 MHz frequency and 600 mVpp amplitude from Fluke 9500B.
- 4) Configure the oscilloscope:
 - a) Press **CH1** in the vertical control area (VERTICAL) at the front panel to enable CH1.
 - b) Rotate **HORIZONTAL**  **SCALE** to set the horizontal time base to 500 ns.
 - c) Rotate **VERTICAL**  **SCALE** to set the vertical scale to 100 mV/div.
 - d) Rotate **HORIZONTAL**  **POSITION** and **VERTICAL**  **POSITION** to set the horizontal position and vertical position to 0 respectively.
 - e) Rotate **TRIGGER**  **LEVEL** to set the trigger level to 0 V.
- 5) Enable the root mean square measurement function of the oscilloscope. Read and record V_{rms1} .
- 6) Output a sine signal with 100 MHz frequency (for 50 MHz bandwidth oscilloscopes, the frequency is 50 MHz) and 600 mVpp amplitude from Fluke 9500B.
- 7) Rotate **HORIZONTAL**  **SCALE** of the oscilloscope to set the horizontal time base to 5 ns (for 50 MHz bandwidth oscilloscopes, the time base is 10 ns).
- 8) Read and record the root mean square V_{rms2} .
- 9) Calculate the amplitude loss: amplitude loss (dB) = $20 \times \lg(V_{\text{rms2}}/V_{\text{rms1}})$.
- 10) Keep the other settings of the oscilloscope unchanged and set the vertical scale to 200 mV/div and 500 mV/div respectively.
- 11) Output sine signals with 1 MHz frequency and 1.2 Vpp/3 Vpp amplitude from Fluke 9500B respectively.
- 12) Repeat step 5).
- 13) Output sine signals with 100 MHz frequency (for 50 MHz bandwidth oscilloscopes, the frequency is 50 MHz) and 1.2 Vpp/3 Vpp amplitude from Fluke 9500B respectively.
- 14) Repeat steps 7), 8) and 9).
- 15) Turn CH1 off. Test CH2 according to the above test steps and record the test results.

Test Record Form:

Channel	Vertical Scale	Test Result	Limit	Pass/Fail
CH1	100 mV/div	Vrms1	≥ -3 dB and ≤ 1 dB	
		Vrms2		
		Amplitude Loss ^[1]		
	200 mV/div	Vrms1		
		Vrms2		
		Amplitude Loss		
	500 mV/div	Vrms1		
		Vrms2		
		Amplitude Loss		
CH2	100 mV/div	Vrms1	≥ -3 dB and ≤ 1 dB	
		Vrms2		
		Amplitude Loss		
	200 mV/div	Vrms1		
		Vrms2		
		Amplitude Loss		
	500 mV/div	Vrms1		
		Vrms2		
		Amplitude Loss		

Note^[1]: amplitude loss (dB) = $20 \times \lg \left(\frac{V_{rms2}}{V_{rms1}} \right)$.







Bandwidth Limit Test

Specification:

Amplitude Loss	-3 dB to 1 dB
Explanation: Amplitude Loss (dB) = $20 \times \lg(V_{\text{rmsn}}/V_{\text{rms1}})$. Wherein, V_{rmsn} represents V_{rms2} and V_{rms3} .	

Test Device: Fluke 9500B

Test procedures:

- 1) Connect the active head of Fluke 9500B to CH1 of the oscilloscope.
- 2) Set the output impedance of Fluke 9500B to 1 MΩ.
- 3) Configure the oscilloscope:
 - a) Press **CH1** in the vertical control area (VERTICAL) at the front panel to enable CH1.
 - b) Rotate **VERTICAL**  **SCALE** to set the vertical scale to 100 mV/div.
 - c) Rotate **HORIZONTAL**  **SCALE** to set the horizontal time base to 500 ns.
 - d) Rotate **HORIZONTAL**  **POSITION** and **VERTICAL**  **POSITION** to set the horizontal position and vertical position to 0 respectively.
 - e) Rotate **TRIGGER**  **LEVEL** to set the trigger level to 0 V.
- 4) Press **CH1** → **BW limit** to enable the function of the bandwidth limit.
- 5) Output a sine waveform with 1 MHz frequency and 600 mVpp amplitude from Fluke 9500B.
- 6) Enable the root mean square measurement function of the oscilloscope. Read and record V_{rms1} .
- 7) Output a sine waveform with 20 MHz frequency and 600 mVpp amplitude from Fluke 9500B.
- 8) Rotate **HORIZONTAL**  **SCALE** of the oscilloscope to set the horizontal time base to 50 ns.
- 9) Read and record root mean square value V_{rms2} .
- 10) Calculate the amplitude loss and compare it to the specification: Amplitude Loss (dB) = $20 \times \lg(V_{\text{rms2}}/V_{\text{rms1}})$. Amplitude loss should be in the range of the specification at this point.
- 11) Output a sine waveform with 50 MHz frequency and 600 mVpp amplitude from Fluke 9500B.
- 12) Rotate **HORIZONTAL**  **SCALE** of the oscilloscope to set the horizontal time base to 20 ns.
- 13) Read and record root mean square value V_{rms2} .
- 14) Calculate the amplitude loss and compare it to the specification: Amplitude Loss (dB) = $20 \times \lg(V_{\text{rms3}}/V_{\text{rms1}})$. Amplitude loss should be lower than -3 dB at this point.
- 15) Keep other settings of the oscilloscope unchanged and set the vertical scale to 200 mV/div.
- 16) Output a sine waveform with 1 MHz frequency and 1.2 Vpp amplitude from Fluke 9500B.

- 17) Repeat step 6).
- 18) Output a sine waveform with 20 MHz frequency and 1.2 Vpp amplitude from Fluke 9500B.
- 19) Repeat step 8), 9) and 10).
- 20) Output a sine waveform with 50 MHz frequency and 1.2 Vpp amplitude from Fluke 9500B.
- 21) Repeat step 12), 13) and 14).
- 22) Keep other settings of the oscilloscope unchanged and set the vertical scale to 500 mV/div.
- 23) Output a sine waveform with 1 MHz frequency and 3 Vpp amplitude from Fluke 9500B.
- 24) Repeat step 6).
- 25) Output a sine waveform with 20 MHz frequency and 3 Vpp amplitude from Fluke 9500B.
- 26) Repeat step 8), 9) and 10).
- 27) Output a sine waveform with 50 MHz frequency and 3 Vpp amplitude from Fluke 9500B.
- 28) Repeat step 12), 13) and 14).
- 29) Turn CH1 off. Test CH2 according to the above test steps and record the test results.

Test Record Form:

Channel	Vertical Scale	Test Result	Limit	Pass /Fail	
CH1	100 mV/div	Vrms1		--	
		Vrms2			
		Vrms3			
		Amplitude Loss ^[1] (dB) = $20 \times \lg^{(V_{rms2}/V_{rms1})}$		≥ -3 dB and ≤ 1 dB	
		Amplitude Loss ^[1] (dB) = $20 \times \lg^{(V_{rms3}/V_{rms1})}$		≤ 3 dB	
	200 mV/div	Vrms1		--	
		Vrms2			
		Vrms3			
		Amplitude Loss ^[1] (dB) = $20 \times \lg^{(V_{rms2}/V_{rms1})}$		≥ -3 dB and ≤ 1 dB	
		Amplitude Loss ^[1] (dB) = $20 \times \lg^{(V_{rms3}/V_{rms1})}$		≤ 3 dB	
	500 mV/div	Vrms1		--	
		Vrms2			
Vrms3					
Amplitude Loss ^[1] (dB) = $20 \times \lg^{(V_{rms2}/V_{rms1})}$			≥ -3 dB and ≤ 1 dB		
Amplitude Loss ^[1] (dB) = $20 \times \lg^{(V_{rms3}/V_{rms1})}$			≤ 3 dB		
CH2	100 mV/div	Vrms1		--	
		Vrms2			
		Vrms3			
		Amplitude Loss ^[1] (dB) = $20 \times \lg^{(V_{rms2}/V_{rms1})}$		≥ -3 dB and ≤ 1 dB	
		Amplitude Loss ^[1] (dB) = $20 \times \lg^{(V_{rms3}/V_{rms1})}$		≤ 3 dB	
	200 mV/div	Vrms1		--	
		Vrms2			
		Vrms3			
		Amplitude Loss ^[1] (dB) = $20 \times \lg^{(V_{rms2}/V_{rms1})}$		≥ -3 dB and ≤ 1 dB	
		Amplitude Loss ^[1] (dB) = $20 \times \lg^{(V_{rms3}/V_{rms1})}$		≤ 3 dB	
	500 mV/div	Vrms1		--	
		Vrms2			
Vrms3					
Amplitude Loss ^[1] (dB) = $20 \times \lg^{(V_{rms2}/V_{rms1})}$			≥ -3 dB and ≤ 1 dB		
Amplitude Loss ^[1] (dB) = $20 \times \lg^{(V_{rms3}/V_{rms1})}$			≤ 3 dB		

Note^[1]: amplitude loss (dB) = $20 \times \lg^{(V_{rmsn}/V_{rms1})}$. Here, Vrmsn represents Vrms2 and Vrms3.





Time Base Accuracy Test

Specification:

Time Base Accuracy	$\leq \pm 50$ ppm
--------------------	-------------------

Test Devices: Fluke 9500B or signal generator and BNC (m)-BNC (m) cable.

Test procedures:

- 1) Connect the active head of Fluke 9500B to CH1 of the oscilloscope.
- 2) Output a sine waveform with 10 MHz frequency and 1 V_{pp} amplitude from Fluke 9500B.
- 3) Configure the oscilloscope:
 - a) Press **CH1** in the vertical control area (VERTICAL) at the front panel to enable CH1.
 - b) Rotate **VERTICAL**  **SCALE** to set the vertical scale to 200 mV/div.
 - c) Rotate **VERTICAL**  **POSITION** to set the vertical position to 0.
 - d) Rotate **HORIZONTAL**  **SCALE** to set the horizontal time base to 20 ns.
 - e) Rotate **HORIZONTAL**  **POSITION** to set the horizontal position to 1 ms.
- 4) Observe the display of the oscilloscope and measure the offset (ΔT) of the midpoint of the signal relative to the center of the screen.
- 5) Calculate the time base accuracy, namely the ratio of ΔT to the horizontal position of the oscilloscope. For example, if the offset of this test is 8 ns, the time base accuracy is 10 ns/1 ms=10 ppm.

Test Record Form:

Channel	Test Result ΔT	Calculation Result	Limit	Pass/Fail
CH1			± 50 ppm	

Zero Point Offset Test

Zero point offset is defined as the offset of the crossing point of the waveform and the trigger level relative to the trigger position as shown in the figure below.

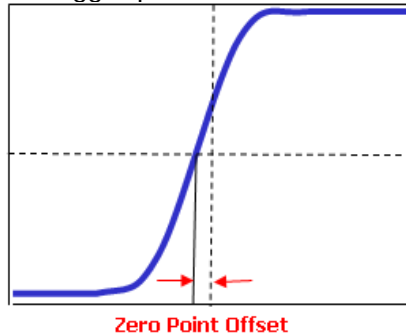

Specification:

Zero Point Offset	500 ps
-------------------	--------

Test Devices: Fluke 9500B

Test Procedures:

- 1) Connect the active head of Fluke 9500B to CH1 of the oscilloscope.
- 2) Output a fast edge signal with 150 ps rise time and 600 mV amplitude from Fluke 9500B.
- 3) Configure the oscilloscope:
 - a) Press **CH1** in the vertical control area (VERTICAL) at the front panel to enable CH1.
 - b) Rotate **VERTICAL** **SCALE** to set the vertical scale to 100 mV/div.
 - c) Rotate **HORIZONTAL** **SCALE** to set the horizontal time base to 2 ns (for 50 MHz bandwidth oscilloscopes, set the horizontal time base to 5 ns).
 - d) Rotate **VERTICAL** **POSITION** and **HORIZONTAL** **POSITION** to set the vertical position and horizontal position to appropriate values respectively.
 - e) Rotate **TRIGGER** **LEVEL** to adjust the trigger level to the middle of the screen.
- 4) Observe the display of the oscilloscope. Press **Cursor** → **Mode** → "Manual" to enable the manual cursor function to measure the zero point offset and record the measurement result.
- 5) Keep other settings unchanged and adjust the amplitude of the fast edge signal to 3 V.
- 6) Set the vertical scale to 500 mV/div. Measure the zero point offset according to the above method and record the test result.
- 7) Turn CH1 off. Repeat the above test steps to measure CH2 and record the test results.

Test Record Form:

Channel	Fast Edge Signal Amplitude	Vertical Scale	Test Result	Limit	Pass/Fail
CH1	600 mV	100 mV/div		≤ 500 ps	
	3 V	500 mV/div			
CH2	600 mV	100 mV/div			
	3 V	500 mV/div			

Chapter 4 Calibration

The oscilloscope can achieve the optimum state fleetly by performing the calibration program and get accurate measurement. You can execute the calibration at any time. But when the operating temperature changes up to or more than 5°C, you must perform this programme.

NOTE:

The oscilloscope must have been working or warm-up **at least 30-minutes** before running self-calibration to get best accuracy.

Steps:

1. Disconnect any probes or cables from all channel inputs, otherwise failure or damage to the oscilloscope may occur.
2. Press **Utility** → **Self-Cal**, enter the Self-Calibration interface.

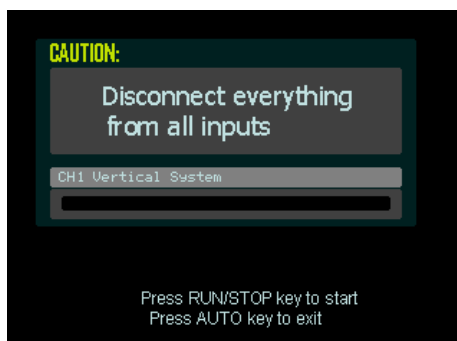

Figure 4-1 Self-Calibration interface

3. Press **RUN/STOP** to start the Self-Calibration, the oscilloscope will calibrate the vertical system (CH1, CH2 and Ext), horizontal system and the trigger system automatically to guarantee the specifications in different environment.
4. The screen will give a message of "Calibration finished" after finish the calibration and you can press **RUN/STOP** to exit.

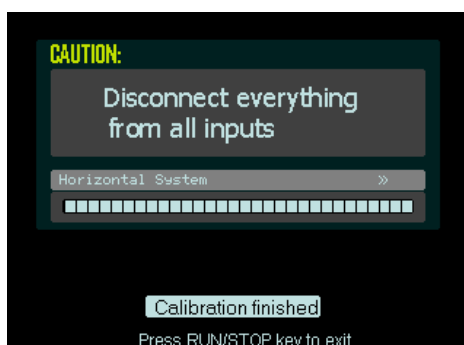

Figure 4-2 Finish Self-Calibration

Generally speaking, the Self-Calibration will take about 5-6 minutes, if the calibration does not pass after this time, or the progress bar stop at one of the calibration item, there may be a trouble to the instrument. To resolve the trouble, restart the instrument and perform the Self-Calibration again, if the problem still remains, contact **RIGOL** for help.

Chapter 5 Disassembly and Assembly

This chapter includes the following topics:

- Notices
- Structure Chart
- Disassemble and Assemble the Cover
- Disassemble and Assemble the Upper and Rear Cover
- Disassemble and Assemble the Power Board and the Fan
- Disassemble and Assemble the Panel
- Disassemble and Assemble LCD and the Keyboard
- Disassemble and Assemble the Mainboard

Notices

Notices:

- Don't disassemble the product except the work needed.
- Disassemble only can be done by qualified person.
- Cut the power before disassembling.
- Take ESD glove under disassembling.
- Use proper tools and follow the disassembly sequence.
- Prevent metallic parts from transfiguration and avoid being scratched when disassembling.

Required tools:

- TORX drivers (T6, T10, T20)
- BNC sleeve



WARNING

Before disassembling, please make sure the power has been cut off. The operator should be trained or had related qualification.

Structure Chart

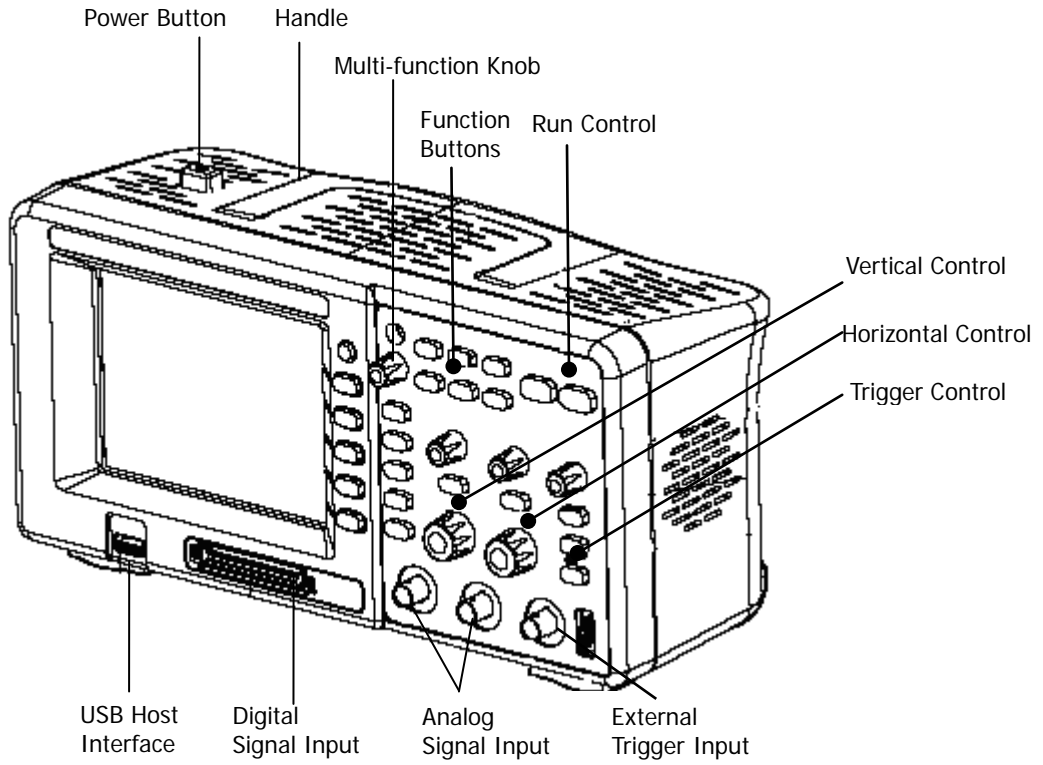

Figure 5-1 Structure chart

Disassemble and Assemble the Cover

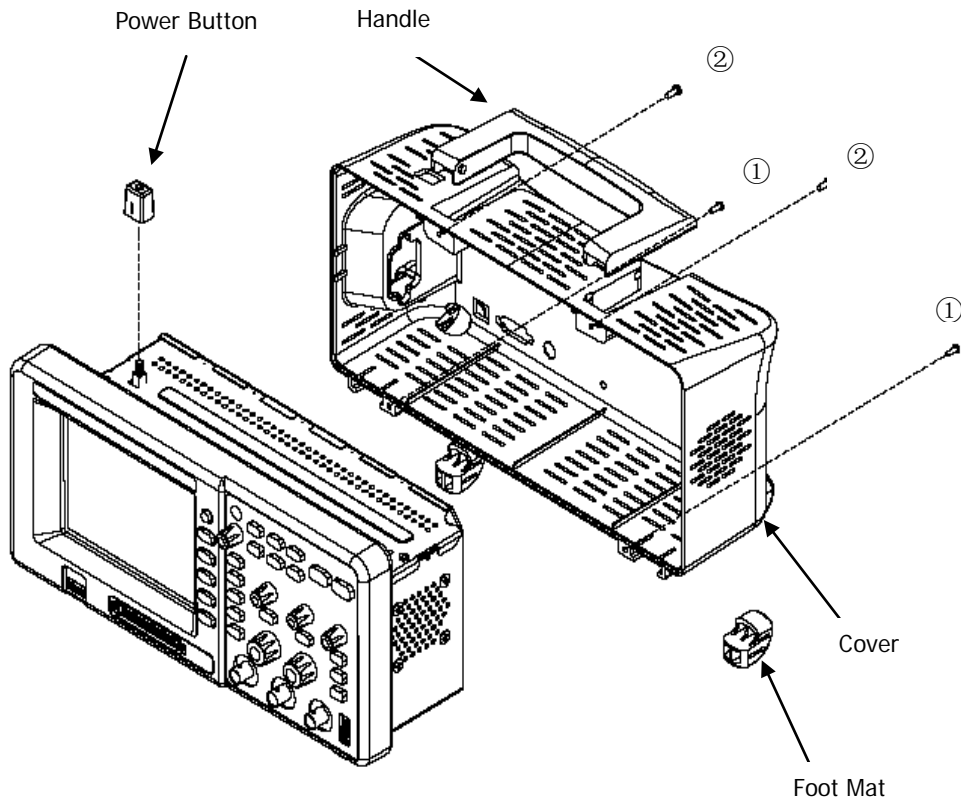

Figure 5-2 Disassemble and assemble the cover

Parts Explanations:

- ① Bolts on the bottom of the cover (M3*8 Pan head Torx recess Drilling tapping screws): 2
- ② Bolts at the groove of the handle (M3*8 Pan head Torx recess machine screws): 2

Disassemble steps:

1. Backout both the two bolts ① and ② using a TORX driver (T10);
2. Jiggle the power button and pull the cap out from it;
3. Remove the cover at the power socket forcibly.

Assemble steps:

About assembly, please operate as reverse orders, the same below.

Disassemble and Assemble the Upper and Rear Covers

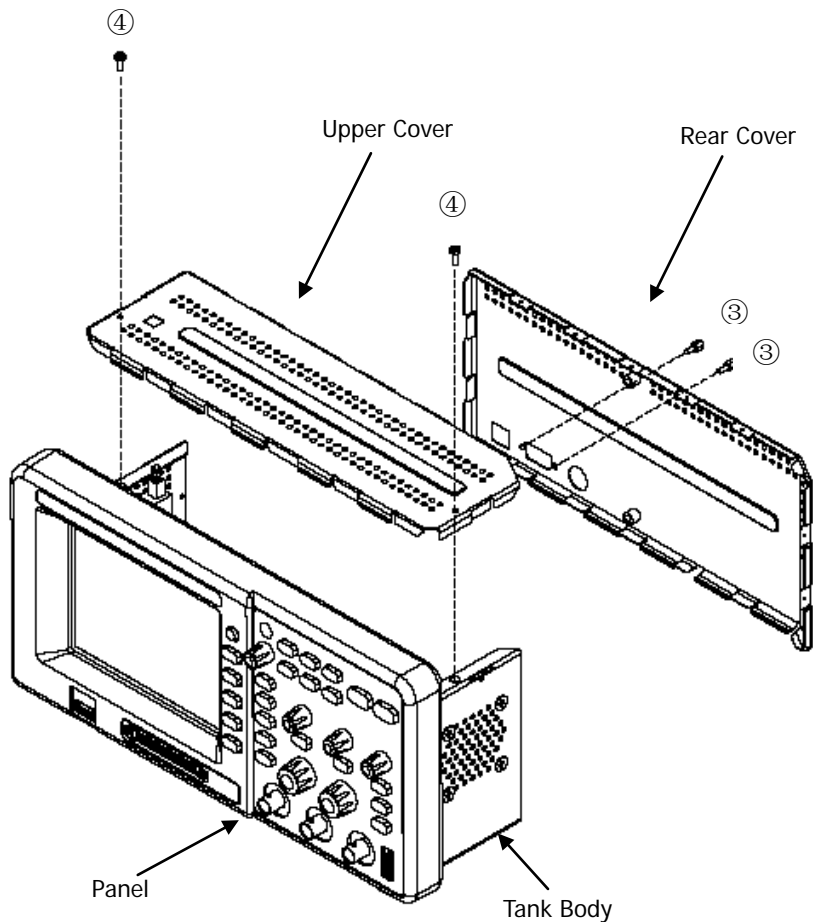

Figure 5-3 Disassemble and assemble the upper and rear covers

Parts Explanations:

- ③ Bolts at the interface of RS-232 (DB9 interface bolts): 2
- ④ Bolts at the upper cover (M3*6 Pan head Torx recess composite machine screws): 2

Disassemble steps:

1. Backout the two bolts ③ and remove the rear cover;
2. Backout the two bolts ④ using a TORX driver (T10); Then, remove the upper cover.

Disassemble and Assemble the Power Board and the Fan

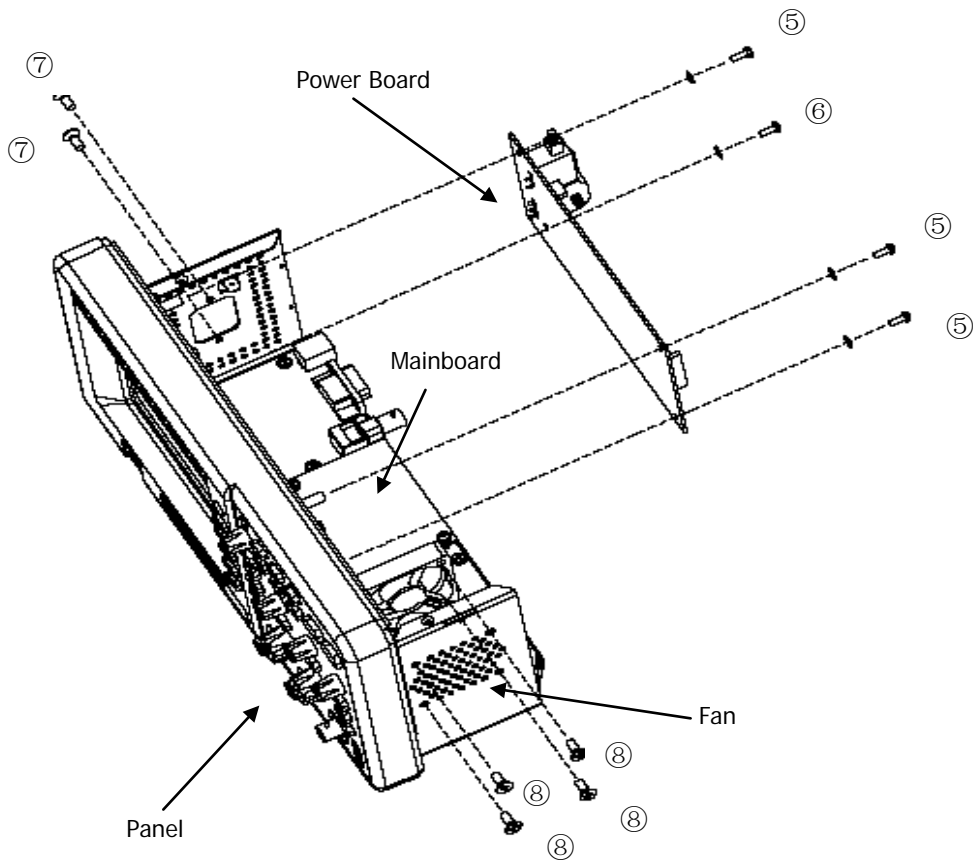

Figure 5-4 Disassemble and assemble the power board and the fan

Parts Explanations:

- ⑤ Small bolts for fixing the power board (M3*6 Pan head Torx recess composite machine screws): 3
- ⑥ Big bolts for fixing the power board (M4*8 Pan head Torx recess machine screws): 1
- ⑦ Bolts (M3*8 Pan head Torx recess Drilling tapping screws) and nuts (M3 hexagon nut with locking plate) for linking up the power board and shell: 2 pairs
- ⑧ Bolts for fixing the fan (M5*8 Pan head Torx recess machine screws): 4

Disassemble steps:

1. Pull out the power line 12pin from the J2 interface of mainboard and the power

- line 2pin for the screen as well as the power ground wire;
2. Back out both the three bolts ⑤ and the bolt ⑥ on the power board separately using TORX driver T10 and T20;
 3. Backout the two bolts and nuts ⑦ for linking up the power board and shell using a TORX driver (T10) and remove the power board;
 4. Pull out the line 12pin power to fan from the J5 interface of mainboard (locates under the fan), and then backout the four bolts ⑧ using a TORX driver (T10) to remove the fan.

Disassemble and Assemble the Panel

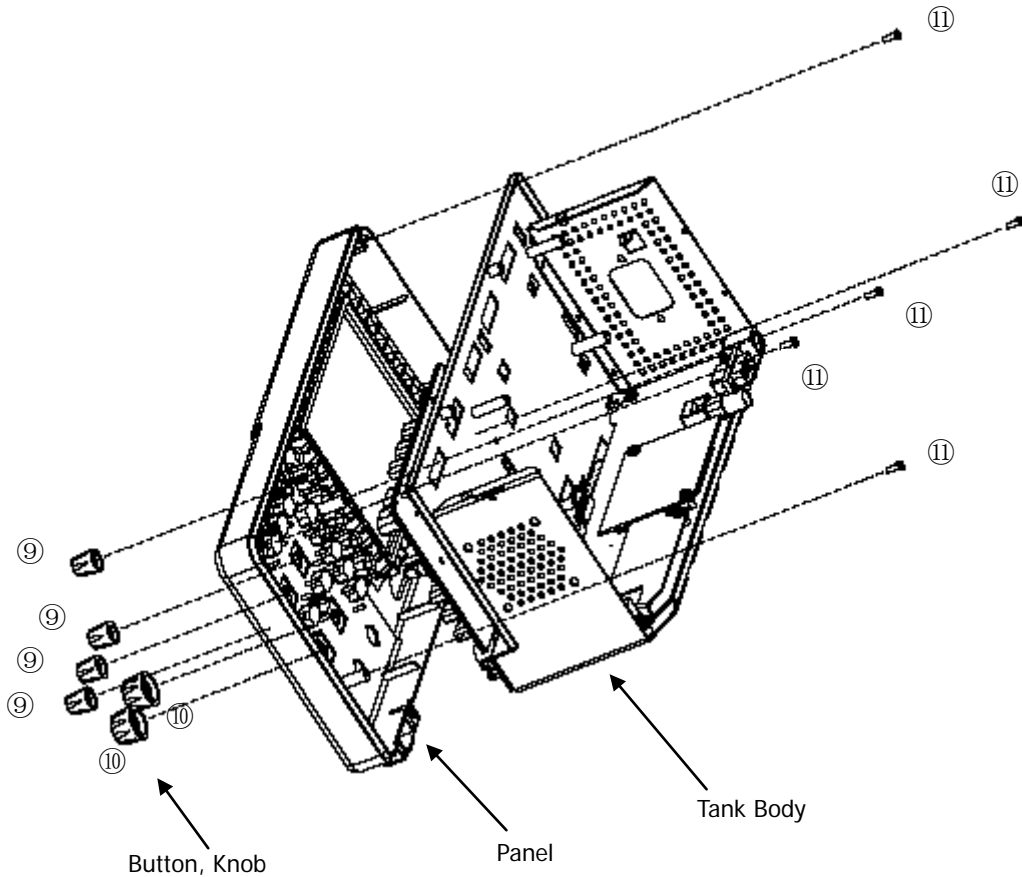

Figure 5-5 Disassemble and assemble the panel

Parts Explanations:

- ⑨ Small knobs: 4
- ⑩ Big knobs: 2
- ⑪ Bolts for fixing board on the tank body (M3*8 Pan head Torx recess Drilling tapping screws): 5

Disassemble steps:

1. Pull out the four small knobs ⑨ and two big knobs ⑩ (note do not damage the board by something hard)
2. Backout the five bolts from the tank body using a TORX driver (T10) to remove the board.

Disassemble and Assemble LCD and the Keyboard

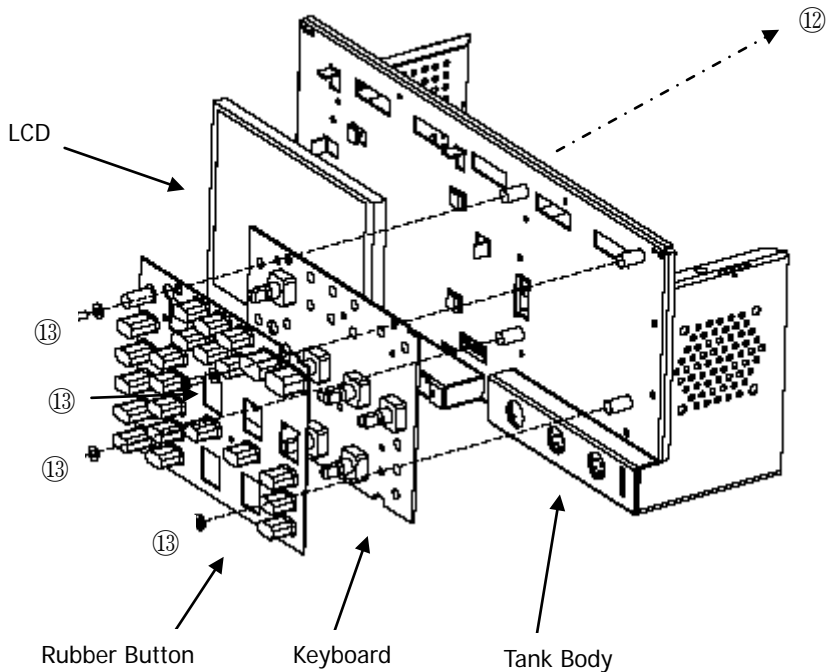

Figure 5-6 Disassemble and assemble LCD and the keyboard

Parts Explanations:

- ⑫ Bolts for the screen ground wire (M2*4 Pan head Torx recess machine screws): 1
- ⑬ Bolts fixed on the keypad board (M3*6 Flush head Torx recess machine screws): 4

Disassemble steps:

1. Pull out the LCD wire from the J603 interface of the mainboard;
2. Backout the one bolt of the screen ground wire using a TORX driver (T6);
3. Take out the LCD screen gently (Be careful the screen cable and ground wire);
4. Backout the keypad board cable from the J604 interface of the mainboard;
5. Backout the four bolts ⑬ from the keypad board using a TORX driver (T10); the moment of force is 6 NM;
6. Take out the keypad board gently (pay attention to the wire).

Disassemble and Assemble the Mainboard

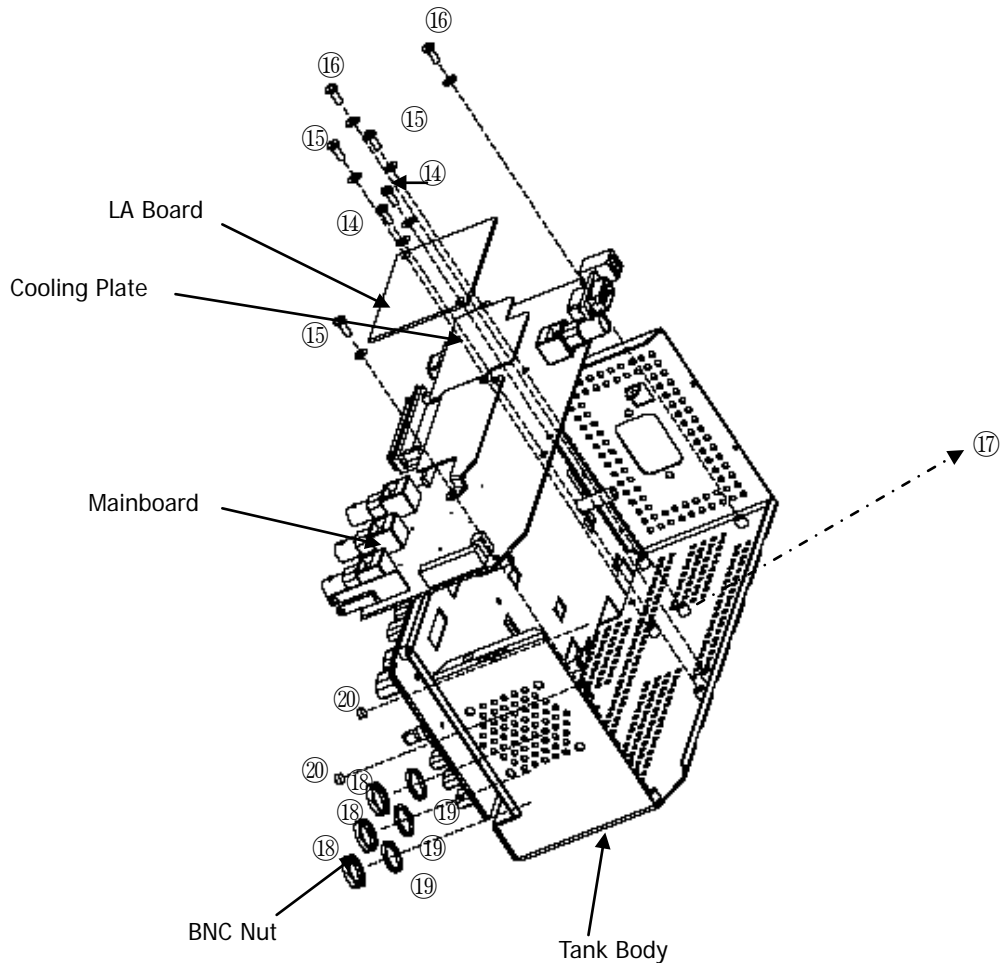

Figure 5-7 Disassemble and assemble the mainboard

Parts Explanations:

- ⑭ Bolts on the LA board ((M3*6 Pan head Torx recess composite machine screws): 2
- ⑮ Bolts on the cooling plate (M3*6 Pan head Torx recess composite machine screws): 3
- ⑯ Bolts for fixing the mainboard (M3*6 Pan head Torx recess composite machine screws): 2
- ⑰ Stud on the mainboard (M3*6 Copper pillar): 3
- ⑱ Nuts at BNC terminal (BNC nuts): 3
- ⑲ Spacer at BNC fracture (BNC lock spacer): 3

⑳ Bolts at LA terminal (0.1*0.3inch Hexagon Bolt in British system): 2

Disassemble steps:

1. Backout the two bolts ⑭ from LA board using a TORX driver (T10);
2. Backout the three bolts ⑮ from the cooling plate using a TORX driver (T10);
3. Backout the two mainboard bolts ⑯ using a TORX driver (T10), and backout the three mainboard studs ⑰ using sleeve (D89); (Pay attention that one M3 spacer is existed between LA board and stud whose position is next to the L808.)
4. Backout the three bolts ⑱ using sleeve, and remove the three spacers ⑲;
5. Backout the two bolts ⑳ at LA terminal using a TORX (T10);
6. Disconnect the earth card on the metal shell from the shore at the USB interface of the mainboard using an electric iron. (Note: please set the temperature of iron as 310℃)
7. Take out the mainboard gently after check.

Chapter 6 Troubleshooting

1. After the oscilloscope is powered on, the screen remains dark (no display):

- (1) Check the power cable connection.
- (2) Ensure the power switch has been turned on.
- (3) After above inspection, restart the oscilloscope.
- (4) If the problem still remains, please ask **RIGOL** for help.

2. After the signal acquisition the waveform does not appear:

- (1) Check if the probe is connecting with the signals.
- (2) Check if the probe is connecting to the channels firmly.
- (3) Check if the probe is connecting with the object being tested.
- (4) Check if any signal generated from testing point.
- (5) Repeat the acquisition.

3. The measurement result is 10 times higher or lower than the value expected.

Check if the probe attenuation corresponds with the channel attenuation.

4. If the oscilloscope does not get a stable waveform display:

- (1) Check the **Source** and notice if it is set to the channel in use.
- (2) Check the **Mode**. Use **Edge** for normal signals, and use **Video** for VIDEO signals.
- (3) Switch the **Coupling** into **HF Rejection** or **LF Rejection** in order to filter the noise which disturbs trigger.
- (4) Adjust the trigger **Sensitivity** and the **Holdoff** time.

5. After pressing **RUN/STOP**, the oscilloscope does not display any waveform on screen.

Check whether the **Sweep** is set to **Normal** or **Single** and see whether the trigger level is out of the signal range. If it is, set the trigger level in proper range by turning the **LEVEL** knob or pressing the **50%** button. Or set the **Mode** as **AUTO**. Moreover, push **AUTO** button to display the waveform on screen.

6. After the Acquisition was set to "Averages" or Display Persistence is set ON, the waveform refreshes slowly.

Normal phenomenon.

7. The waveform is displayed on the appearance of ladder.

- (1) Normal phenomenon. Maybe the time base setting maybe is too slow. Please

rotate the horizontal SCALE knob to increase horizontal resolution to improve the display.

- (2) Maybe the display **Type** is set to **Vectors** set it to **Dots** mode to improve the display.

Chapter 7 Replaceable Parts

RIGOL provides some replaceable parts in order to maintain or update for users. Please see as the following figure and table. Note that the numbers in the figure and the table are associated with each other.

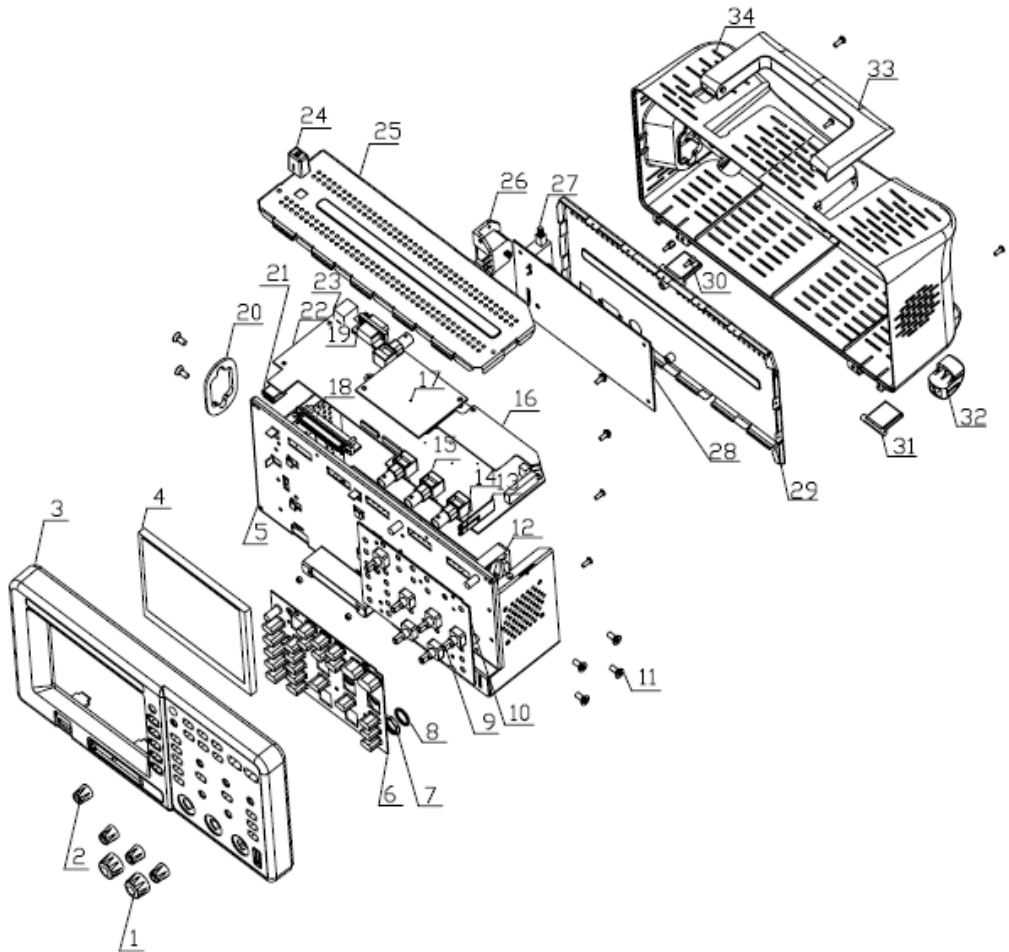

Figure 7-1 DS1000E, DS1000D Exploded View

Table 7-1 Replaceable parts list

No.	Name	Specification
1	Big Knob	
2	Small Knob	
3	Panel	
4	LCD	Color Screen: FG050600ANNNA-01
5	Metallic Tank Body	
6	Rubber Button	
7	BNC Nut	BNC Nut
8	BNC Lock Spacer	BNC Lock Spacer
9	Encoder	
10	Keyboard	
11	Bolt	0.1*0.3inch Hexagon Bolt, British system
12	Fan	AFB0612LC-714
13	Large Terminal	
14	Small Terminal	
15	BNC	
16	Cooling Plate	Aluminum
17	LA Board	
18	LA Interface	
19	RS-232 Interface	
20	Power Jacket	
21	USB Host Interface	
22	Mainboard	RDSB1003
23	USB Device Interface	
24	Power Switch Cap	
25	Upper Metallic Cover	
26	Power Interface	
27	Power Supply	
28	Power Board	RDSB1001
29	Rear Metallic Cover	
30	Female ScrewLock	M3*7/ DB9 bolt, British system
31	Front Trestle	
32	Rear Trestle	
33	Handle	
34	Cover	

Chapter 8 Service & Support

This chapter contains the following topics:

- Warranty
- Care and Cleaning
- Contact Us

Warranty

RIGOL warrants that its products mainframe and accessories will be free from defects in materials and workmanship within the warranty period. If a product proves defective within the respective period, **RIGOL** guarantees the free replacement or repair of products which are approved defective.

To get repair service or obtain a copy of the whole warranty statement, please contact with your nearest **RIGOL** sales and service office.

RIGOL does not provide any other warranty items except the one being provided by this summary and the warranty statement. The warranty items include but not being subjected to the hint guarantee items related to tradable characteristic and any particular purpose.

RIGOL will not take any responsibility in cases regarding to indirect, particular and ensuing damage.

Care and Cleaning

General Maintenance

Do not store or leave the instrument in where the instrument will be exposed to direct sunlight for long periods of time.

Caution

To avoid damages to the instrument or probes, do not expose them to liquids which have causticity.

Cleaning

Clean the instrument and probes often based on its operating conditions require. To clean the exterior surface, perform the following steps:

1. Disconnect the instrument from all power sources.
2. Clean the loose dust on the outside of the instrument and probes with a lint-free cloth (with a mild detergent and water). When clean the LCD, take care to avoid scarifying it.



WARNING

To avoid injury resulting from short circuit, make sure the instrument is completely dry before reconnecting into a power source.

Contact Us

If you have any problem or requirement when using our products, please contact RIGOL Technologies, Inc. or your local distributors, or visit: www.rigol.com.